

Assembly instruction

Texas 2so, 3so, 3x1so

2so, 3so

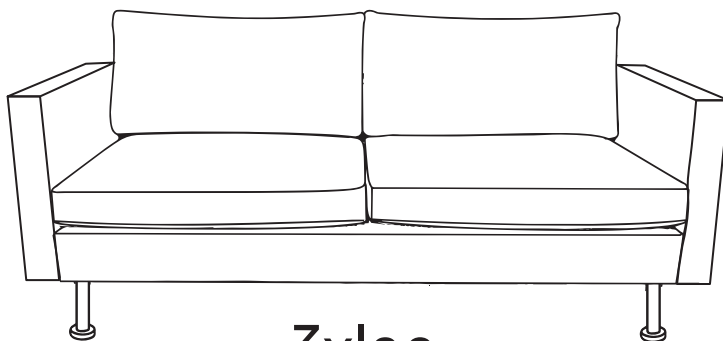

3x1so

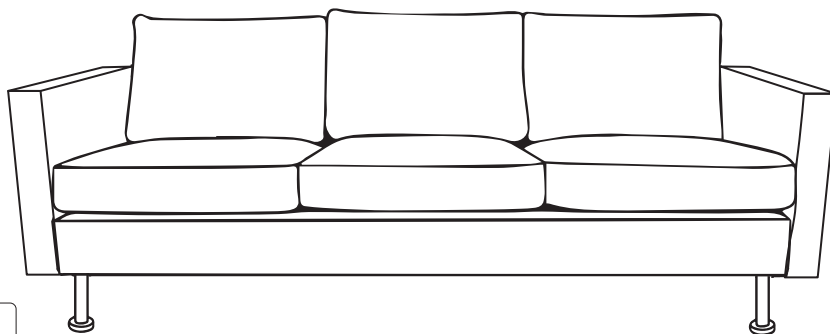

FSC
www.fsc.org

MIX

Wood from
responsible sources

FSC® C103689

You need



10 minutes



2 people

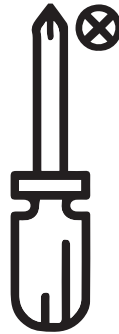
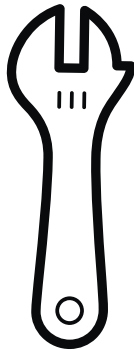

Components

Wooden leg

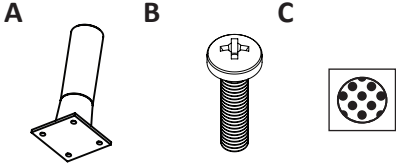

Nr	QTY	mm
A	4	H:160
B	16	M6x20
C	4	

Metal leg

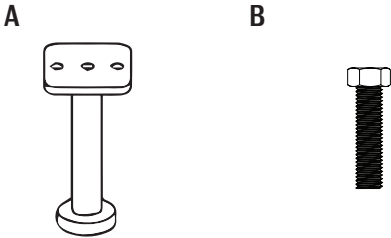

Nr	QTY	mm
A	4	H:160
B	8	M8x30

Mounting

Follow the instructions step by step

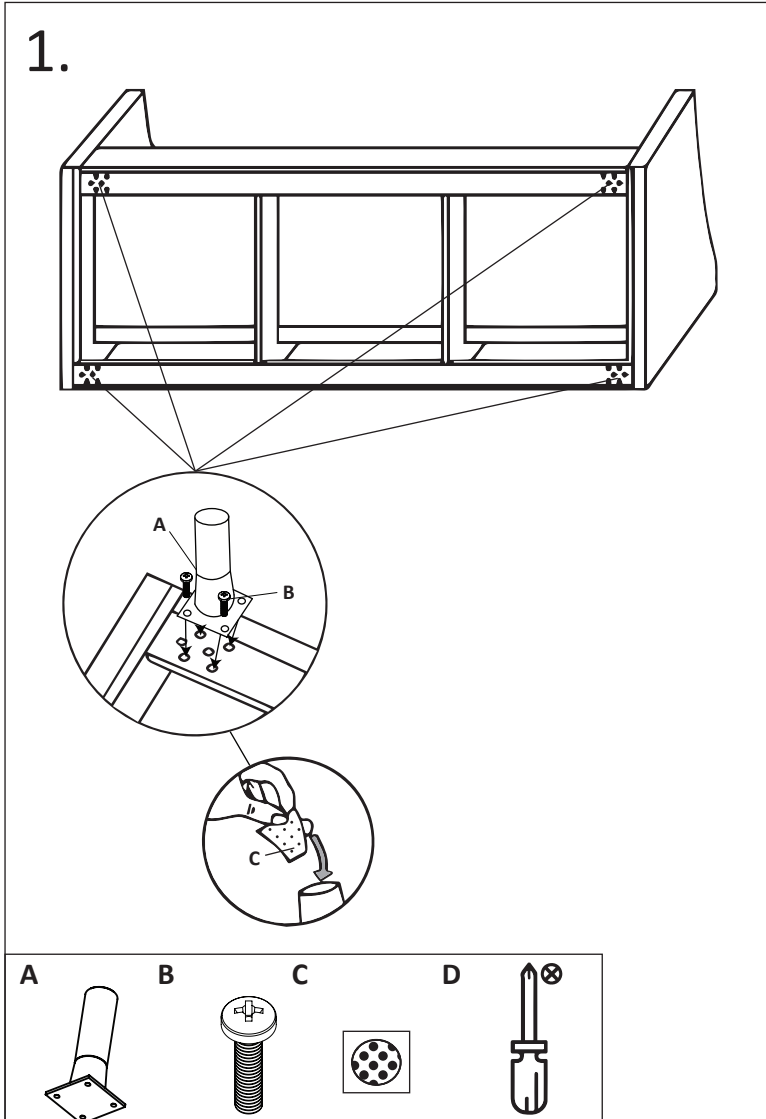

Mounting

Follow the instructions step by step

